



แบบทดสอบชั้นประถมศึกษาปีที่ 6  
กลุ่มสาระการเรียนรู้ภาษาต่างประเทศ (ภาษาอังกฤษ)  
ปีการศึกษา 2562

สำนักทดสอบทางการศึกษา  
สำนักงานคณะกรรมการการศึกษาขั้นพื้นฐาน

แบบทดสอบนี้เป็นเอกสารสงวนลิขสิทธิ์ของสำนักทดสอบทางการศึกษา  
สำนักงานคณะกรรมการการศึกษาขั้นพื้นฐาน ถ้าคัดลอก ดัดแปลง เฉลยเพื่อ  
จำหน่าย หรือนำไปเผยแพร่โดยไม่ได้รับอนุญาต จะถูกดำเนินคดีตามกฎหมาย

# คำชี้แจงแบบทดสอบกลุ่มสาระการเรียนรู้ภาษาต่างประเทศ (ภาษาอังกฤษ) ชั้นประถมศึกษาปีที่ 6

1. แบบทดสอบภาษาอังกฤษมีทั้งหมด 40 ข้อ คะแนนเต็ม 100 คะแนน เวลา 75 นาที
2. แบบทดสอบแบ่งเป็น 3 ตอน ดังนี้

**ตอนที่ 1**      **แบบเลือกตอบ** เลือกคำตอบที่ถูกที่สุดเพียงคำตอบเดียว จำนวน 30 ข้อ (ข้อ 1 – 30)  
(ข้อละ 2 คะแนน รวม 60 คะแนน)

ตัวอย่าง 0.

Mom: It's time to go to bed.

Jack: Okay, Mom. \_\_\_\_\_

- 1) Goodbye.
- 2) Good evening.
- 3) Good night.
- 4) Good afternoon.

**วิธีตอบ** ให้นักเรียนเลือกคำตอบที่ถูกที่สุดเพียงคำตอบเดียว โดยระบายทับหมายเลขที่สอดคล้องกับตัวเลือกที่ต้องการลงในกระดาษคำตอบ ถ้านักเรียนคิดว่า ตัวเลขที่ 3 เป็นคำตอบที่ถูกต้อง ให้ระบายทับหมายเลข ดังนี้

0   ①   ②   ●   ④

**ตอนที่ 2**      **แบบเชิงซ้อน** ให้เลือกคำตอบที่ถูกที่สุดในแต่ละข้อย่อย จำนวน 2 ข้อ (ข้อ 31 – 32)  
(ข้อละ 8 คะแนน รวม 16 คะแนน      ตอบถูกทั้ง 4 ข้อย่อย      ได้ 8 คะแนน  
ตอบถูก 3 ข้อย่อย      ได้ 6 คะแนน      ตอบถูก 2 ข้อย่อย      ได้ 4 คะแนน  
ตอบถูก 1 ข้อย่อย      ได้ 2 คะแนน      ตอบไม่ถูกหรือไม่ตอบ      ได้ 0 คะแนน)

ตัวอย่าง

**Read the passage and answer the questions.** (ตัวอย่าง 00 – 000)

Today is a weekend. Bill and Tony go to the market at noon. Bill buys a loaf of bread and a cup of coffee. Tony buys a bottle of water. They also buy hamburgers.

ตัวอย่าง 00. Choose **TRUE** if the sentence is correct or **FALSE** if the sentence is not correct.

00.1 Tony and Bill go shopping on a weekend.	TRUE	FALSE
00.2 Tony buys a cup of coffee and a hamburger.	TRUE	FALSE
00.3 Bill and Tony buy hamburgers.	TRUE	FALSE
00.4 Bill and Tony buy a bottle of water.	TRUE	FALSE

วิธีตอบ ถ้านักเรียนคิดว่าข้อย่อยที่ 00.1 "TRUE" เป็นคำตอบที่ถูกที่สุด ข้อย่อยที่ 00.2 "FALSE" เป็นคำตอบที่ถูกที่สุด ข้อย่อยที่ 00.3 "TRUE" เป็นคำตอบที่ถูกที่สุด และข้อย่อยที่ 00.4 "FALSE" เป็นคำตอบที่ถูกที่สุด ให้ระบาย ดังนี้

		TRUE	FALSE
00	00.1	●	②
	00.2	①	●
	00.3	●	②
	00.4	①	●

ตอนที่ 3 แบบเขียนตอบสั้น ให้เขียนคำตอบที่ถูกต้องลงในกระดาษคำตอบ จำนวน 8 ข้อ (ข้อ 33 – 40) (ข้อละ 3 คะแนน รวม 24 คะแนน)

ตัวอย่าง 000. At noon, they buy food for their \_\_\_\_\_.

วิธีตอบ ถ้านักเรียนคิดว่าคำตอบที่ถูกต้องคือ lunch ให้นักเรียนเติมคำว่า lunch ลงในช่องว่าง ดังนี้

**Answer:** \_\_\_\_\_ lunch \_\_\_\_\_

หมายเหตุ ให้นักเรียนเติมเฉพาะคำตอบ ไม่ต้องลอกโจทย์

ห้ามเปิดข้อสอบจนกว่ากรรมการกำกับการสอบจะอนุญาต

**Part 1 Multiple Choices: Choose the best answer for each question. (Items 1 – 30)**

ตอนที่ 1 แบบเลือกตอบ เลือกคำตอบที่ถูกต้องที่สุดเพียงคำตอบเดียว ข้อ 1 – 30

1.

Teacher says, "Write your name on the blackboard".

What should the student do?

1)

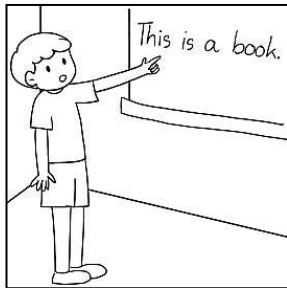

2)

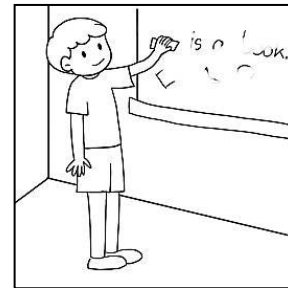

3)



4)

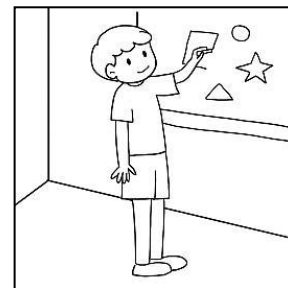

2.

**How to Plant Seeds**

- A. Next, sprinkle the seeds over the soil.
- B. Finally, place the pot in a warm place.
- C. First, fill the pot with soil.
- D. Then, cover the pot with a transparent material.



Rearrange the following steps in the **CORRECT** order.

1) C – A – D – B

2) C – B – D – A

3) C – D – B – A

4) C – D – A – B

3.



From the sign, \_\_\_\_\_ can park here.



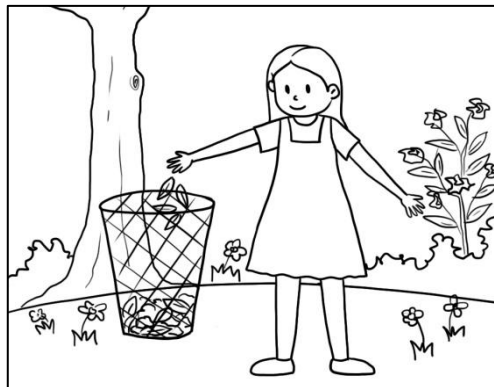

- 1) John and his strong father
- 2) Rick and his disabled wife
- 3) Marisa and her crying babies
- 4) Andrea and her drunk husband

4. From the picture, which sentence is **TRUE**?



- 1) The girl is planting seeds in the pot.
- 2) The girl is growing flowers in the park.
- 3) The girl is watering plants in the garden.
- 4) The girl is putting leaves in the garbage bin.

5. Look at the weather forecast.

THU	FRI	SAT	SUN	MON
				

Tom is going to the scout camp on Saturday. He should bring \_\_\_\_\_ with him.

- |               |               |
|---------------|---------------|
| 1) gloves     | 2) a raincoat |
| 3) a swimsuit | 4) sunglasses |

6.



This sign means \_\_\_\_\_.

- |                            |                                 |
|----------------------------|---------------------------------|
| 1) a pet shop is ahead     | 2) pets are not allowed         |
| 3) you can buy the animals | 4) you should beware of animals |

7.

Yesterday was the special day. Jimmy woke up and found a large present at the end of his bed. It was wrapped in brown paper. Jimmy's brother, John, and his parents came into his bedroom. They brought a big cake with candles and sang a song for him.

Why yesterday was special for this family?

- |                            |                             |
|----------------------------|-----------------------------|
| 1) It was Father's Day.    | 2) It was Mother's Day.     |
| 3) It was John's birthday. | 4) It was Jimmy's birthday. |



8.

James: I'm going camping. What do I need?

Dad: A tent and a flashlight. You can get them from the garage.

James: Thanks, Dad.

Dad: \_\_\_\_\_

- |                    |                      |
|--------------------|----------------------|
| 1) What a pity!    | 2) You're welcome.   |
| 3) That's too bad. | 4) Long time no see! |

9.

Danny: "Happy Mother's Day", this gift is for you.

Mom: I really love it! \_\_\_\_\_

- |                    |                       |
|--------------------|-----------------------|
| 1) It's too bad.   | 2) My pleasure.       |
| 3) You're welcome. | 4) Thank you so much. |

10.

**At the bus stop**

Tourist: Excuse me. \_\_\_\_\_ how to get to the museum?

Jane: Sure. Go along this street about five hundred meters.

You will see the museum on the left.

Tourist: Thank you.

- |                           |                           |
|---------------------------|---------------------------|
| 1) Could you tell me      | 2) May I show you         |
| 3) May I give you the way | 4) Could you listen to me |

11.

**It's late at night.**

Elsa: Mom, \_\_\_\_\_, please?

Mother: No, dear. It's bedtime.

- |                     |                      |
|---------------------|----------------------|
| 1) can I sleep now  | 2) may I stay home   |
| 3) can I go outside | 4) may I take a rest |

12.

**In the office**

Nick: My computer is not working. \_\_\_\_\_

Tom: Sure. Let me see.

- 1) Why do you fix it?
- 2) What's wrong with you?
- 3) Could you give me some help?
- 4) How do staff fix broken computer?

13.

**On the phone**

Kim: Tim, can you take me to the airport tomorrow?

Tim: \_\_\_\_\_ I'll have a meeting. I'm so sorry.

- |                |                    |
|----------------|--------------------|
| 1) Certainly.  | 2) Yes, please.    |
| 3) No, thanks. | 4) I'm afraid not. |

14.

**In the classroom**

Jane: Can you help me plan the party?

Tom: \_\_\_\_\_ What can I do for you?

Jane: Well, I need you to help me make a list of guests.

- |                |                    |
|----------------|--------------------|
| 1) I'm sorry.  | 2) Not at all.     |
| 3) No, thanks. | 4) Yes, of course. |





15.

**At the supermarket**

Adam: Have you heard about Lisa?

Eva: She's fine. Why?

Adam: I really miss her. \_\_\_\_\_

Eva: Let me see. It's 09-1234-9876.

- |                         |                              |
|-------------------------|------------------------------|
| 1) How old is she?      | 2) What is her name?         |
| 3) Where does she live? | 4) What is her phone number? |

16.

**At home**

David: Let's have a pizza for dinner this evening.

Bella: Pizza? \_\_\_\_\_ What about steak?

David: OK.

- |                       |                        |
|-----------------------|------------------------|
| 1) I'm bored of it.   | 2) I really love it.   |
| 3) That sounds great. | 4) That's a good idea. |

17.

Teacher: How was your skiing trip last week?

Robert: \_\_\_\_\_ It was freezing and I had a bad cold.

- |               |              |
|---------------|--------------|
| 1) Great!     | 2) Terrible! |
| 3) Excellent! | 4) Amazing!  |

18.

It has four sides and four corners. Two sides are shorter and the other two are longer. It is a \_\_\_\_\_.

- |           |              |
|-----------|--------------|
| 1) circle | 2) triangle  |
| 3) square | 4) rectangle |

19.

**Profile**

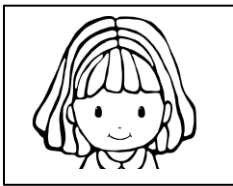
	Name	: Malee Deejai
	Date of Birth	: _____
	Age	: 12 years old
	Height	: 155 centimeters
	Weight	: 45 kilograms
	Nationality	: Thai

1) 23/05/2007

2) 08-1123-4567

3) ID. 1650300245896

4) 404/20 Sukhumvit Rd.

20.

There are 36 students in the classroom. The teacher asks them about their favorite social media used. Half of the students always use Facebook. Five of them use Instagram and ten of them like Line. The others love Twitter.

From the passage, which one is **CORRECT**?

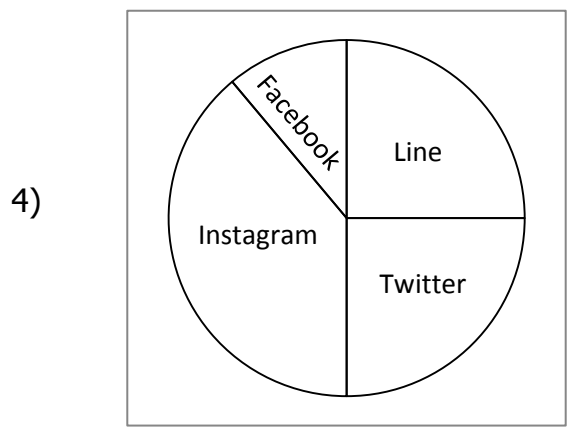
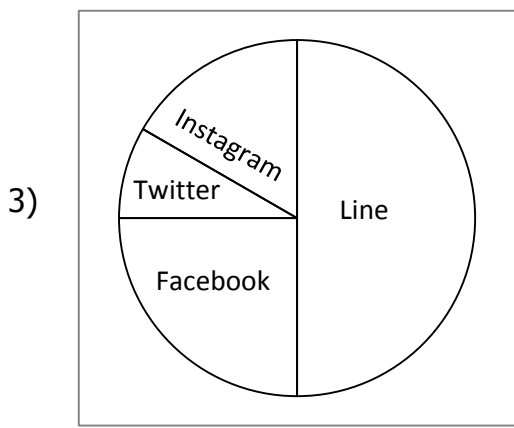
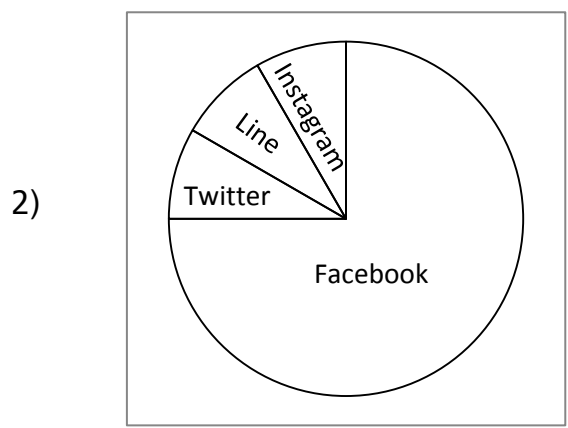
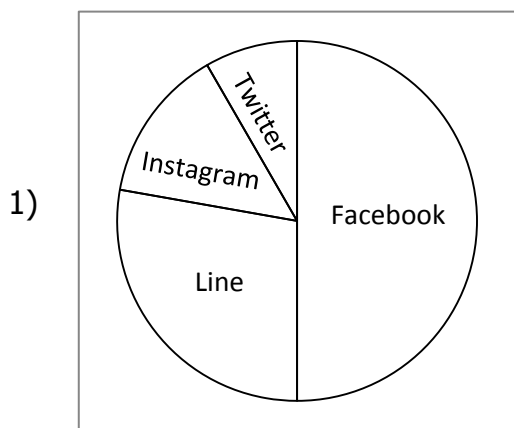





21.

### Jane's Weekly Breakfast Plan





Jane will have toast on Monday and Bacon on Tuesday. On Wednesday, she wants pancakes. On Thursday, she will make fried eggs, and she will eat fruits on Friday.

 Which one is **CORRECT**?



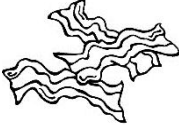

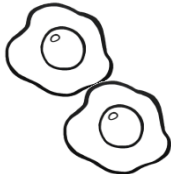
1)

Monday	Tuesday	Wednesday	Thursday	Friday
				

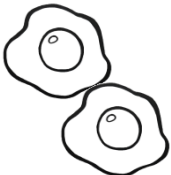
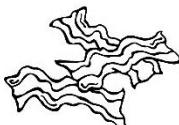

2)

Monday	Tuesday	Wednesday	Thursday	Friday
				

3)

Monday	Tuesday	Wednesday	Thursday	Friday
				

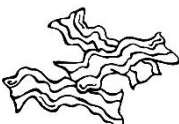
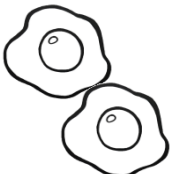
4)

Monday	Tuesday	Wednesday	Thursday	Friday
				



22. I love living in Thailand. It is a beautiful country, and \_\_\_\_\_.

- 1) beaches are dirty
- 2) people are friendly
- 3) the traffic is terrible
- 4) the weather is too hot

23. This weekend, the weather will be very bad. I think \_\_\_\_\_.

- 1) it's fun to take a walk on the beach
- 2) playing football in the field is interesting
- 3) having a picnic in the park is a good idea
- 4) it's better to watch TV at home than going out

24. Your close friend won a scholarship to study in Japan.

What should you say to him?

- 1) Thank you.
- 2) That's terrible.
- 3) Congratulations!
- 4) I'm sorry to hear that.

25. Many people are taking photos with big pine trees. The trees are decorated with lights, stars, bells, gifts, and red stockings. They're very beautiful. You can see them on \_\_\_\_\_.

- 1) Easter
- 2) Halloween
- 3) Christmas
- 4) Valentine's Day



26.

Children knock neighbors' doors from house to house and say  
" \_\_\_\_\_ " on 31<sup>st</sup> of October.

- |                    |                   |
|--------------------|-------------------|
| 1) Trick or Treat  | 2) Happy birthday |
| 3) Merry Christmas | 4) Happy New Year |

27. Which sentence uses **CORRECT** punctuation?

- |                              |                                 |
|------------------------------|---------------------------------|
| 1) What a lovely day?        | 2) How wonderful you are?       |
| 3) May I go outside, please. | 4) Put your hands on your desk. |

28. Rearrange the following words to make a **CORRECT** sentence.

the shortest	Bangkok	This	road	to	.	is
1	2	3	4	5	6	7

- |                              |                              |
|------------------------------|------------------------------|
| 1) 3 – 7 – 4 – 1 – 2 – 5 – 6 | 2) 2 – 4 – 7 – 3 – 5 – 1 – 6 |
| 3) 3 – 7 – 1 – 4 – 5 – 2 – 6 | 4) 2 – 4 – 5 – 1 – 7 – 3 – 6 |

29.

At Christmas, most of western people go back to their hometowns  
to spend time with their families. In Thailand, we usually do this at  
\_\_\_\_\_.

- |                  |                   |
|------------------|-------------------|
| 1) Songkran      | 2) Loy Kratong    |
| 3) Teacher's Day | 4) Children's Day |



30.

**In the classroom**

Teacher: We are going to learn a new word, "ASTRONAUT".

Students: \_\_\_\_\_

Teacher: A person who is trained to work in a spaceship.

1) How do you do?

2) What does it mean?

3) Why do you spell it?

4) When do you read it?

**Part 2 Complex Multiple Choices: Choose TRUE or FALSE. (Items 31 – 32)**

ตอนที่ 2 แบบเชิงซ้อน ให้เลือกคำตอบที่ถูกต้องที่สุดในแต่ละข้อย่อย ข้อ 31 – 32

31.

Paul was driving home after working at 8 p.m. Suddenly, a dog ran to his car. He immediately stopped his car. Then, he got off his car to look for the dog. He found that the dog was safe. He took it home and took good care of it.



Choose **TRUE** if the sentence is correct or **FALSE** if the sentence is not correct.

31.1 Paul was on his holiday.	TRUE	FALSE
31.2 Paul was driving home at night.	TRUE	FALSE
31.3 The dog was not hurt.	TRUE	FALSE
31.4 Paul is a dog lover.	TRUE	FALSE

32.

CLASS RULES	
1	Listen to the teacher.
2	Raise your hand to speak.
3	Keep classroom clean.
4	Be kind to others.
5	Don't eat in class.

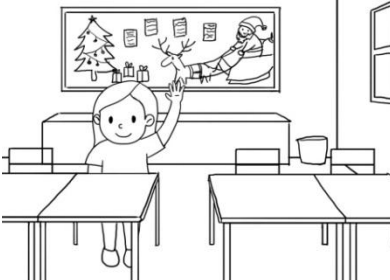
From the class rules above, choose **TRUE** if the picture is correct or **FALSE** if it is not correct.

32.1		TRUE	FALSE
32.2		TRUE	FALSE
32.3		TRUE	FALSE
32.4		TRUE	FALSE

**Part 3 Short Answer: Answer the questions in the answer sheet. (Items 33 – 40)**

ตอนที่ 3 แบบเขียนตอบสั้น ให้เขียนคำตอบที่ถูกต้องลงในกระดาษคำตอบ ข้อ 33 – 40

33.

**At the playground**

Helen found a kitten in a bush. She took it home. She fed it with milk and fish. She took good care of it and called it "Mimi".

From the story, what is Helen like?

She is a \_\_\_\_\_ girl.

**Answer:** \_\_\_\_\_

34.

Williams: Mark, this is my brother, Eddy.

Mark: \_\_\_\_\_, Eddy. I'm Mark. Nice to meet you.

Eddy: Hello, Mark. Nice to meet you, too.

**Answer:** \_\_\_\_\_

35.

**After an English Summer Camp**

Alex: It's really nice that we met.

Daniel: Yes. Let's keep in touch.

Alex: May I have your \_\_\_\_\_ address?

Daniel: Sure. It's Daniel234@gmail.com.

**Answer:** \_\_\_\_\_



36.

**In Bangkok**

Tony: Where are you going this weekend?

Peter: I am going to Chiang Mai with my family.

Tony: How will you get there?

Peter: By \_\_\_\_\_. I enjoy seeing the view along the road.

**Answer:** \_\_\_\_\_

37.

Dolphins, whales, sharks, jellyfish and starfish are \_\_\_\_\_ animals.

**Answer:** \_\_\_\_\_

38.

Tomorrow I will have a picnic with my friends. I will bring \_\_\_\_\_ to drink and fried chicken to eat.

**Answer:** \_\_\_\_\_

39.

On Valentine's Day, people usually give \_\_\_\_\_ to people they love.

**Answer:** \_\_\_\_\_

40.

**In the classroom**

Teacher: What subject do you like?

Student: I like \_\_\_\_\_ because I love singing and playing the guitar.

**Answer:** \_\_\_\_\_